

F-152XP

Electrical Specifications (@25C)

1. Maximum Power: 7.5 VA
2. Primary: 115V 50/60 Hz
3. Secondary: Series: 15.0V CT @ 0.50 Amps
Parallel: 7.5V CT @ 1.00 Amps

Description:

The F-152XP is part of a wide selection of plug-in types that meet the needs of PC boards and solid state power supply design. This transformer can satisfy power as well as control and instrumentation applications.

Construction:

Wound on a single channel nylon bobbin. Materials are UL recognized, Class B (130° C) rated.

Safety:

These products are 100% hipot tested with an insulation of 1500V between primary and secondary windings.

Dimensions:

Units: In inches

| A | B | C | D | E | F |
|-------|-------|-------|-------|-------|-------|
| 1.625 | 2.812 | 1.468 | 2.375 | 0.406 | 1.312 |

Mounting hole: 0.187 in.

Pin length: 0.187 in.

Pin size: 0.20 x .041 in.

Weight: 10.5 oz

Schematic:

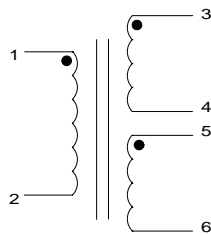

- Primary: 1 to 2
 Secondary: Series - 3 to 6, Jumper 4 to 5
 Parallel - 3 to 5, Jumper 3 to 5 and 4 to 6

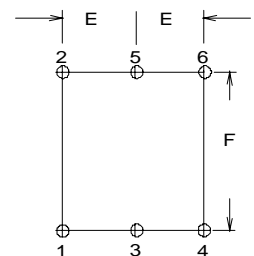
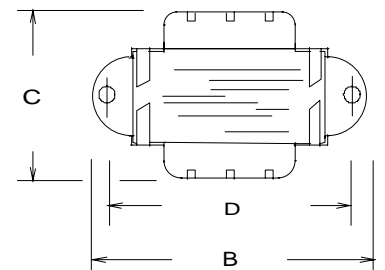
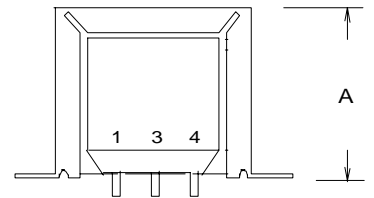

RoHS Compliance: As of manufacturing date February 2005, all standard products meet the requirements of 2002/95/EC, known as the RoHS initiative.

Power Transformers

PC Mount

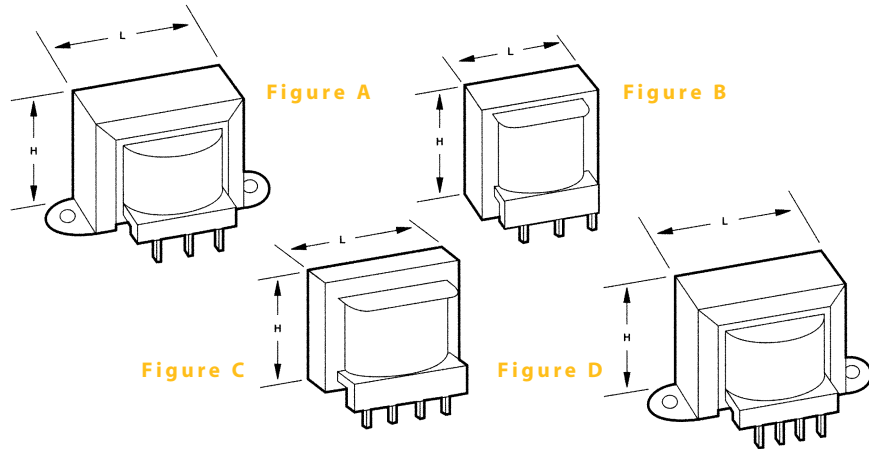

:: Description

Triad power transformers are offered in a wide selection of plug-in types to meet the needs of PC board and solid state power supply designs. These transformers can satisfy power as well as control and instrumentation applications. The transformers are available in single or dual primary and dual center tapped secondary configurations.

:: Specifications

Primary: 115 V, 50/60 Hz

:: Single Primary, Dual Secondaries

| Section | Type No. | Figure | VA | Secondary | | Dimensions | | | | | | Wt. Oz. | |
|---------|----------|--------------------|----------------|--------------------|----------------|------------------|--------------|----|----|----|----|---------|-----|
| | | | | Series | Parallel | H | W | D | L | A | B | | MW |
| A | F-131P | B | 1½ | 8.0V CT @ 0.188A | 4.0V @ 0.376A | 1⅜ | • | 1½ | 1⅝ | ⅝ | 1 | • | 3.5 |
| | F-139P | | | 12.6V CT @ 0.12A | 6.3V @ 0.24A | | | | | | | | |
| | F-132P | | | 15.0V CT @ 0.100A | 7.5V @ 0.200A | | | | | | | | |
| | F-150P | | | 17.0V CT @ 0.085A | 8.5V @ 0.170A | | | | | | | | |
| | F-138P | | | 25.2V CT @ 0.06A | 12.6V @ 0.12A | | | | | | | | |
| | F-133P | | | 30.0V CT @ 0.050A | 15.0V @ 0.100A | | | | | | | | |
| | F-160P | | | 34.0V CT @ 0.045A | 17.0V @ 0.090A | | | | | | | | |
| | F-137P | | | 40.0V CT @ 0.038A | 20.0V @ 0.076A | | | | | | | | |
| | F-134P | | | 54.0V CT @ 0.028A | 27.0V @ 0.056A | | | | | | | | |
| | F-135P | | | 76.0V CT @ 0.020A | 38.0V @ 0.040A | | | | | | | | |
| | F-136P | | | 116.0V CT @ 0.013A | 58.0V @ 0.026A | | | | | | | | |
| | B | | | F-141XP | A | | | | | | | | |
| F-149XP | | 12.6V CT @ 0.35A | 6.3V @ 0.70A | | | | | | | | | | |
| F-142XP | | 15.0V CT @ 0.300A | 7.5V @ 0.600A | | | | | | | | | | |
| F-161XP | | 17.0V CT @ 0.264A | 8.5V @ 0.528A | | | | | | | | | | |
| F-148XP | | 25.2V CT @ 0.178A | 12.6V @ 0.356A | | | | | | | | | | |
| F-143XP | | 30.0V CT @ 0.150A | 15.0V @ 0.300A | | | | | | | | | | |
| F-162XP | | 34.0V CT @ 0.132A | 17.0V @ 0.264A | | | | | | | | | | |
| F-147XP | | 40.0V CT @ 0.112A | 20.0V @ 0.224A | | | | | | | | | | |
| F-144XP | | 54.0V CT @ 0.084A | 27.0V @ 0.168A | | | | | | | | | | |
| F-145XP | | 76.0V CT @ 0.060A | 38.0V @ 0.120A | | | | | | | | | | |
| F-146XP | | 116.0V CT @ 0.033A | 58.0V @ 0.066A | | | | | | | | | | |
| C | | F-151XP | A | 7½ | | 8.0V CT @ 0.940A | 4.0V @ 1.88A | 1⅝ | 2⅝ | 1⅝ | 1⅝ | ⅝ | 1⅜ |
| | F-159XP | 12.6V CT @ 0.60A | | | 6.3V @ 1.2A | | | | | | | | |
| | F-152XP | 15.0V CT @ 0.500A | | | 7.5V @ 1.000A | | | | | | | | |
| | F-163XP | 17.0V CT @ 0.441A | | | 8.5V @ 0.882A | | | | | | | | |
| | F-158XP | 25.2V CT @ 0.30A | | | 12.6V @ 0.60A | | | | | | | | |
| | F-153XP | 30.0V CT @ 0.250A | | | 15.0V @ 0.500A | | | | | | | | |
| | F-164XP | 34.0V CT @ 0.220A | | | 17.0V @ 0.440A | | | | | | | | |
| | F-157XP | 40.0V CT @ 0.188A | | | 20.0V @ 0.376A | | | | | | | | |
| | F-154XP | 54.0V CT @ 0.140A | | | 27.0V @ 0.280A | | | | | | | | |
| | F-155XP | 76.0V CT @ 0.100A | | | 38.0V @ 0.200A | | | | | | | | |
| | F-156XP | 116.0V CT @ 0.085A | | | 58.0V @ 0.130A | | | | | | | | |

CT = Center Tap Mounting hole size: Figure A = ⅜"

:: 115 Volts, 50/60 Hz Primary/Triple Output Secondaries for ±15 VDC and +5 VDC

| Section | Type No. | Figure | VA | Secondary | | Dimensions | | | | | | Wt. Oz. | |
|---------|--------------------|--------|----|--|---------------------------------------|------------|----|----|----|---|----|---------|------|
| | | | | Secondary No. 1 | Secondary No. 2 | H | W | D | L | A | B | | MW |
| D | F-165P F-167P | C | 1½ | 24.0V CT @ 0.025A 32.0V CT @ 0.020A | 9.0VCT @ 0.100A 15.0V CT @ 0.060A | 1⅜ | 1⅝ | 1½ | 1⅝ | ⅝ | 1 | • | 3.5 |
| E | F-168XP | D | 4½ | 32.0V CT @ 0.050A | 15.0V CT @ 0.195A | 1⅜ | 2⅜ | 1¼ | 1⅝ | ¼ | 1½ | 2 | 7.5 |
| F | F-166XP F-169XP | D | 7½ | 24.0V CT @ 0.125A 32.0V CT @ 0.100A | 9.0V CT @ 0.500A 15.0V CT @ 0.287A | 1⅝ | 2⅝ | 1⅝ | 1⅝ | ¼ | 1⅜ | 2⅝ | 10.5 |

CT = Center Tap Mounting hole size: Figure A = ⅜"

Outline Dimensions

Technical Notes

1. Hi-pot tested at 1,500 VRMS.

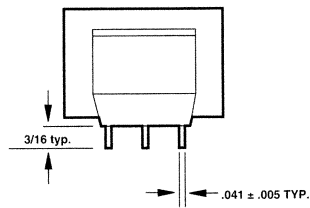
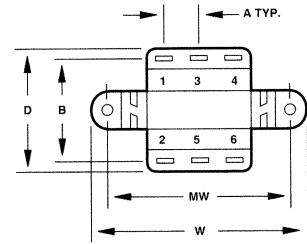
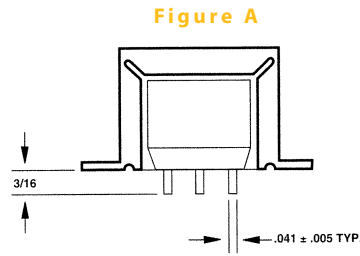
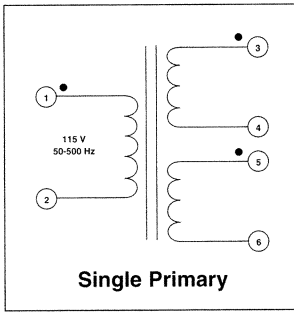

Figure B

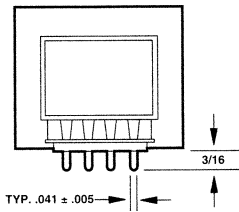
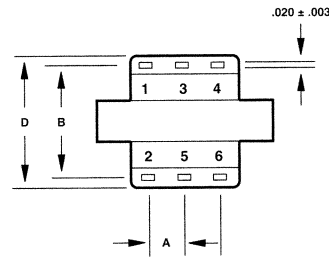

Figure C

